

ONE RIVER POINT

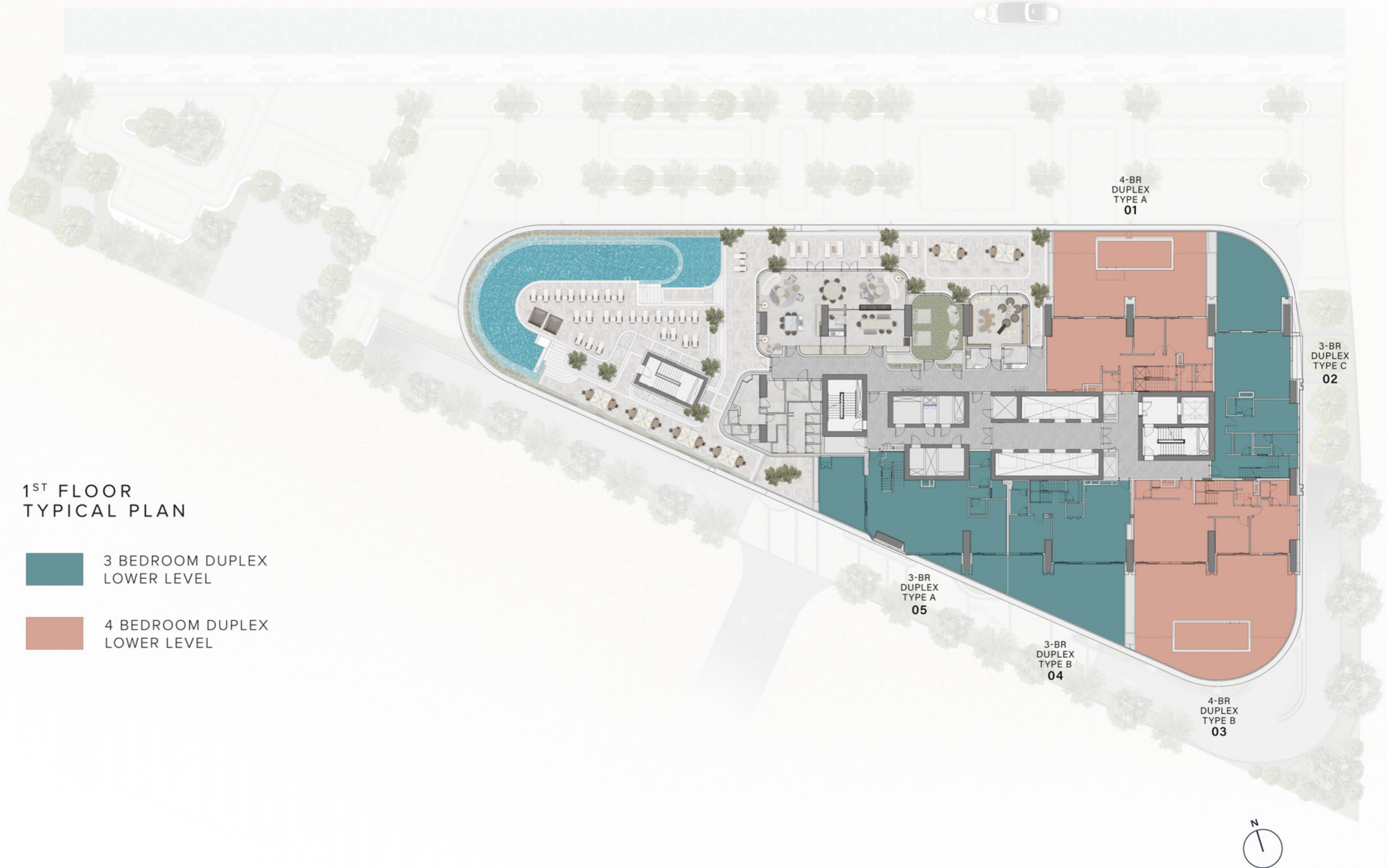

FLOOR PLAN

ONE RIVER POINT



ONE RIVER POINT



2ND FLOOR TYPICAL PLAN

-  3 BEDROOM DUPLEX
UPPER LEVEL
-  4 BEDROOM DUPLEX
UPPER LEVEL



ONE RIVER POINT



ONE RIVER POINT

4TH FLOOR TYPICAL PLAN

-  1 BEDROOM
-  2 BEDROOM

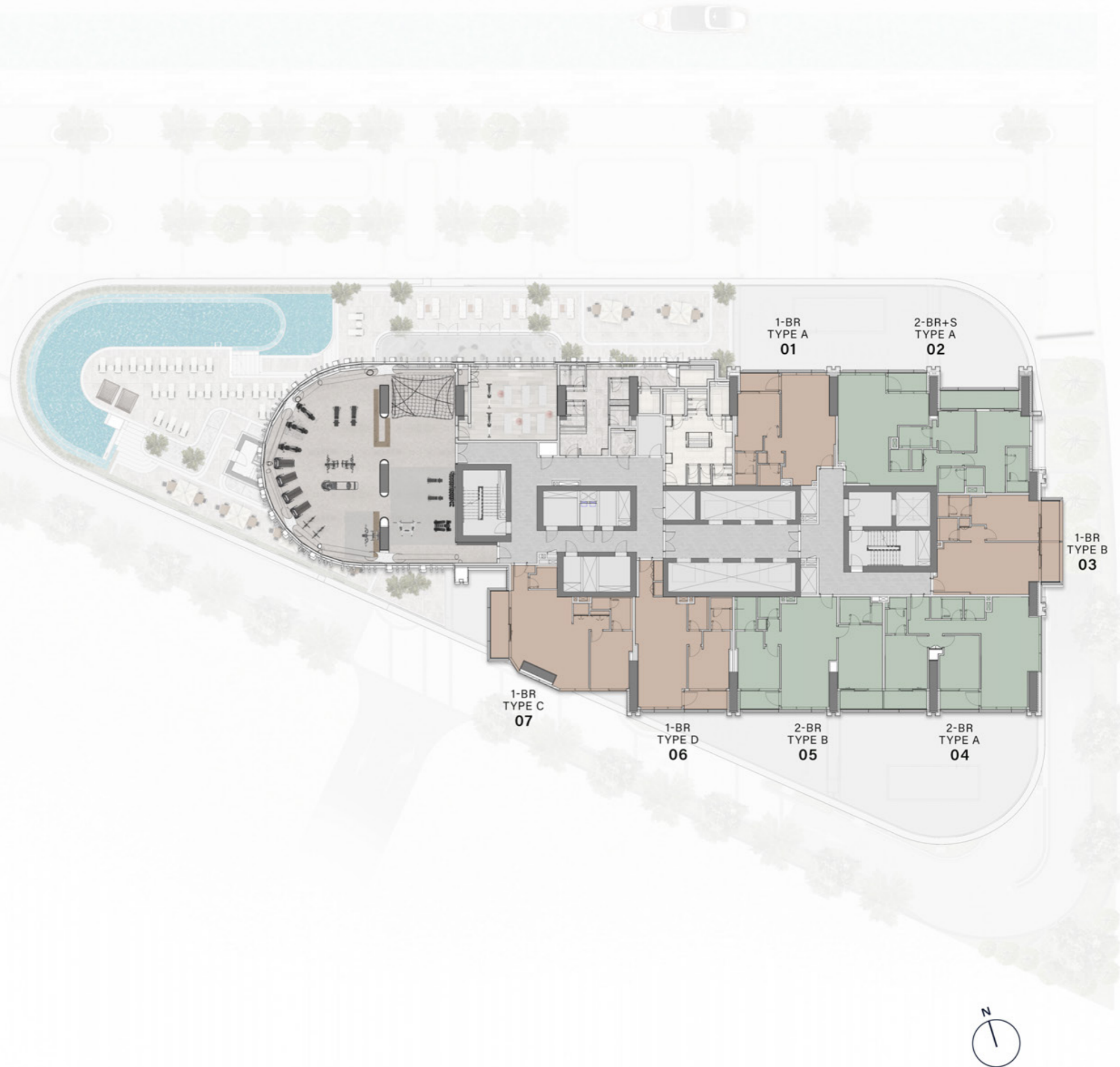

ONE RIVER POINT

5TH FLOOR TYPICAL PLAN

-  1 BEDROOM
-  2 BEDROOM

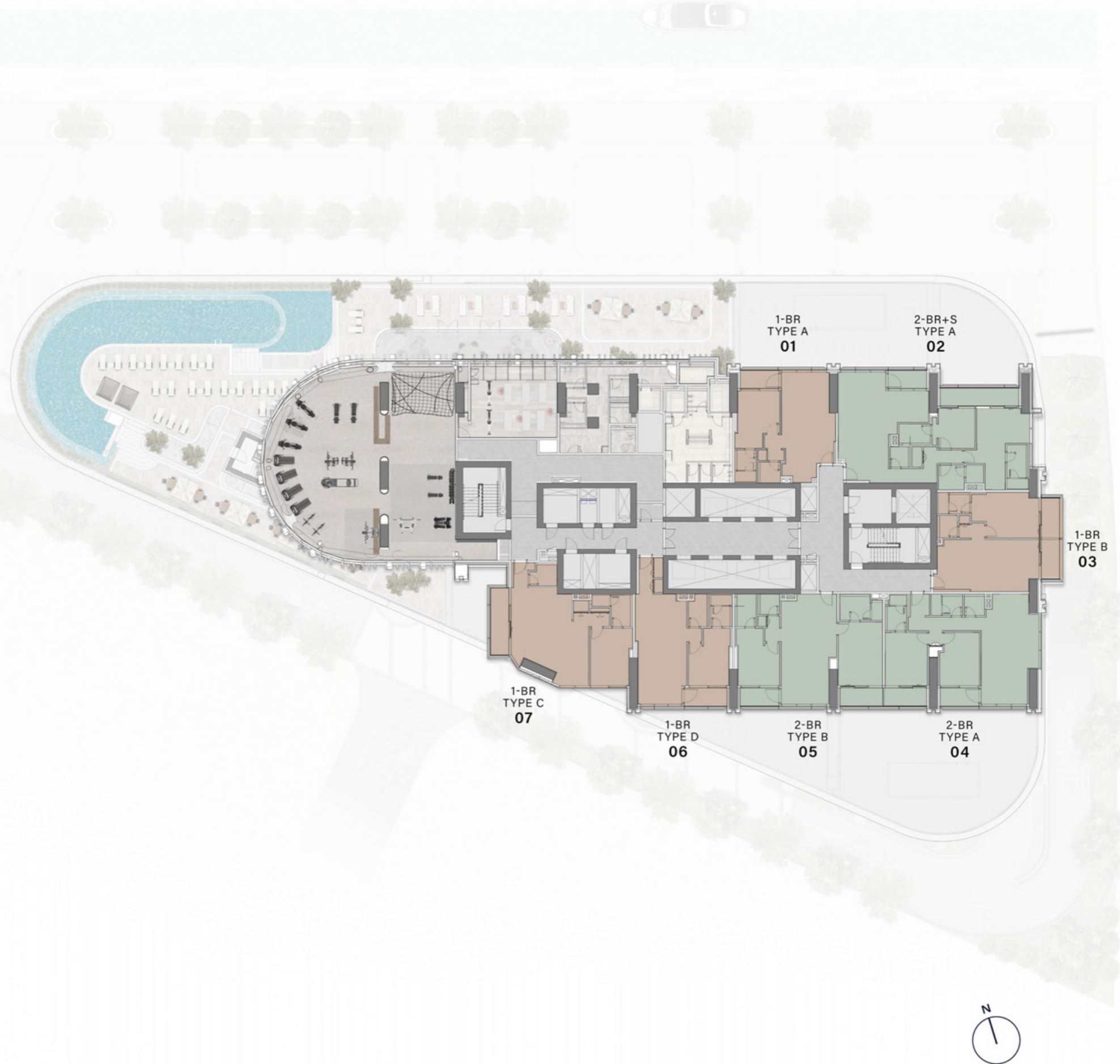

ONE RIVER POINT

6TH FLOOR TYPICAL PLAN

-  1 BEDROOM
-  2 BEDROOM



ONE RIVER POINT

7TH FLOOR TYPICAL PLAN

-  1 BEDROOM
-  2 BEDROOM



ONE RIVER POINT

8TH - 16TH FLOOR TYPICAL PLAN

-  1 BEDROOM
-  2 BEDROOM
-  3 BEDROOM

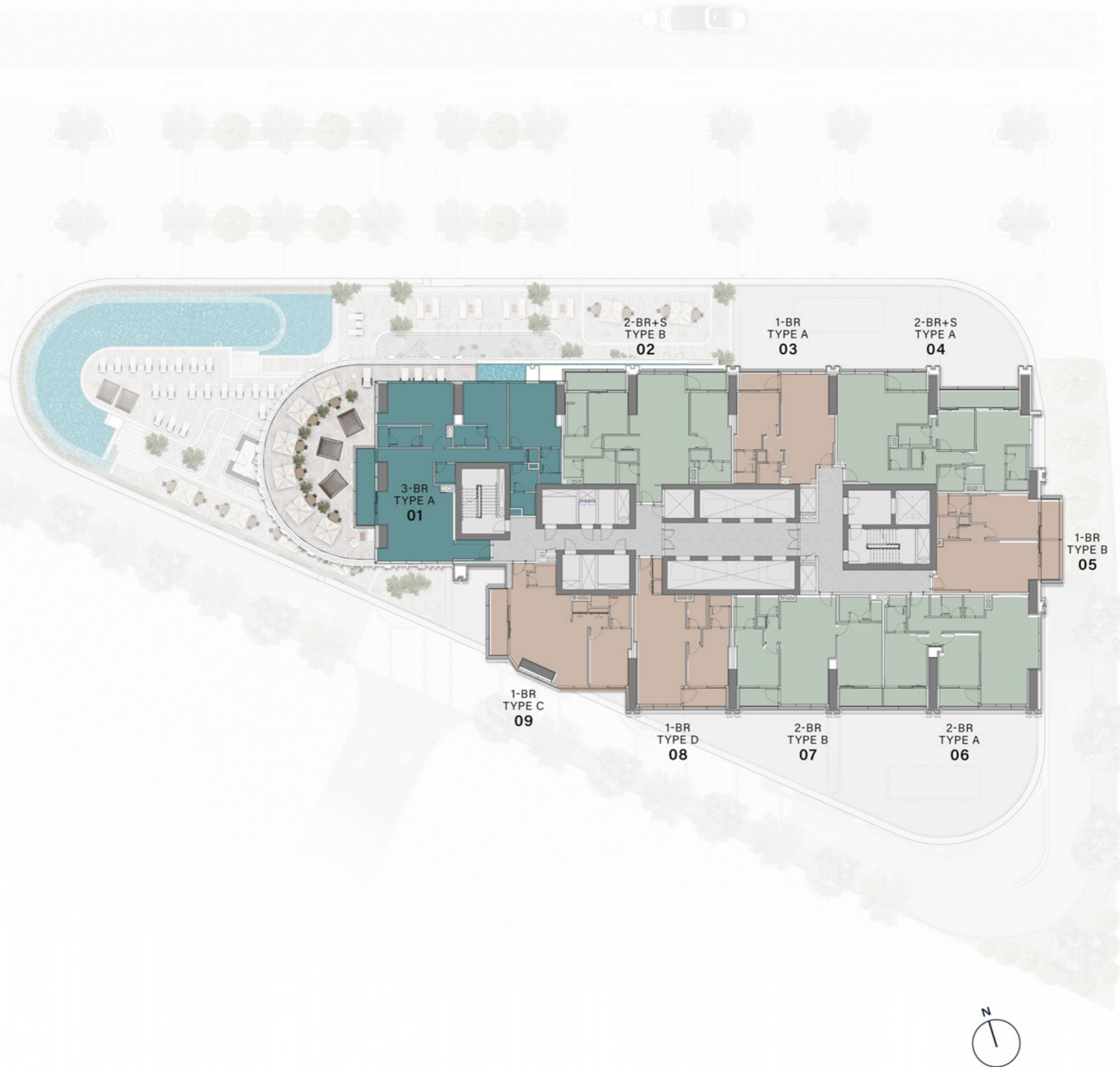

ONE RIVERPOINT

18TH - 36TH FLOOR TYPICAL PLAN

-  STUDIO
-  1 BEDROOM
-  2 BEDROOM
-  3 BEDROOM



ONE RIVER POINT

37TH FLOOR TYPICAL PLAN

-  3 BEDROOM
PENTHOUSE
-  4 BEDROOM
PENTHOUSE

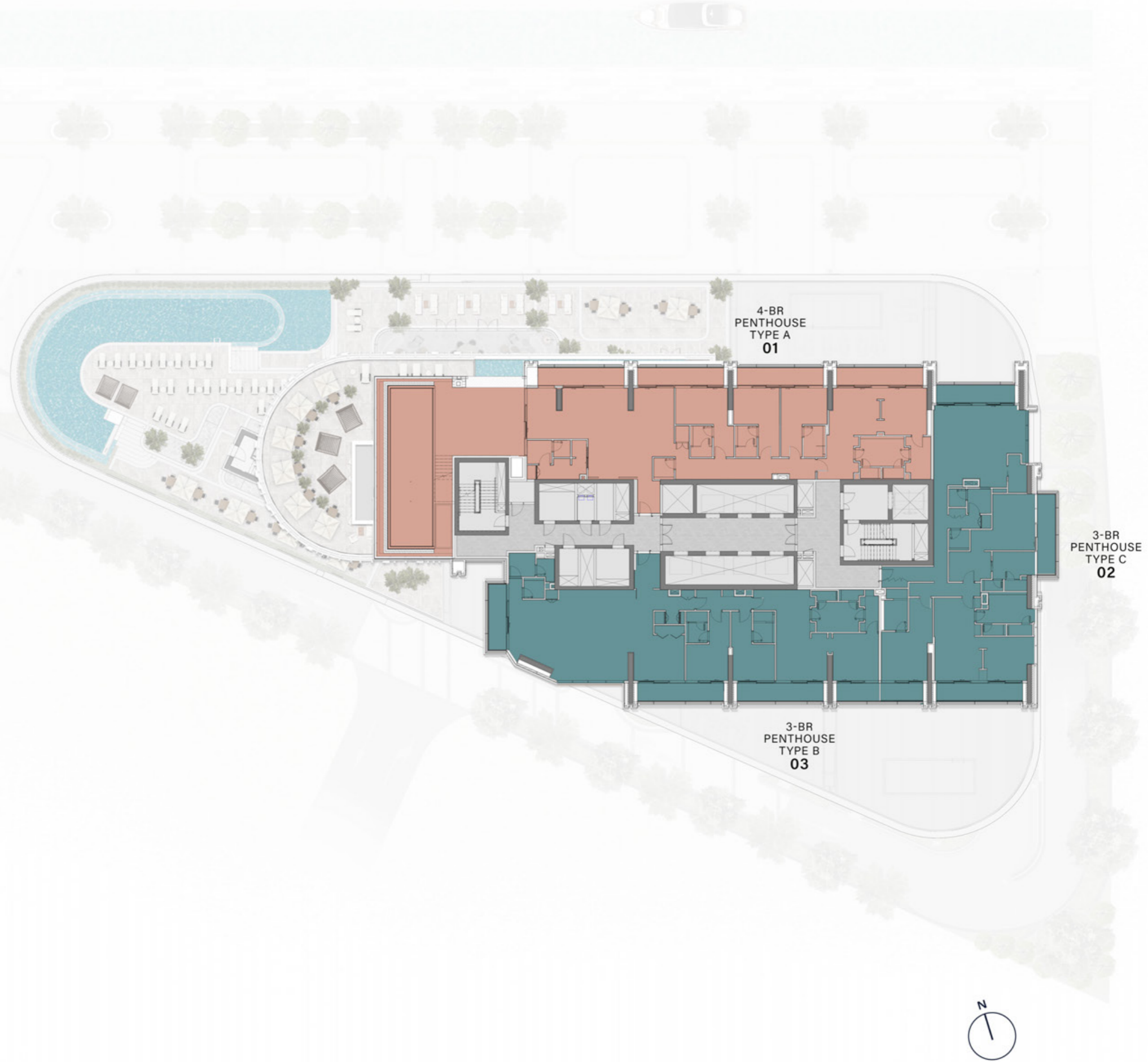

STUDIO

TYPE A

Internal Living Area : **401.06 Sq. Ft**

Outdoor Living Area : **86.43 Sq. Ft**

Total Living Area : **487.50 Sq. Ft**

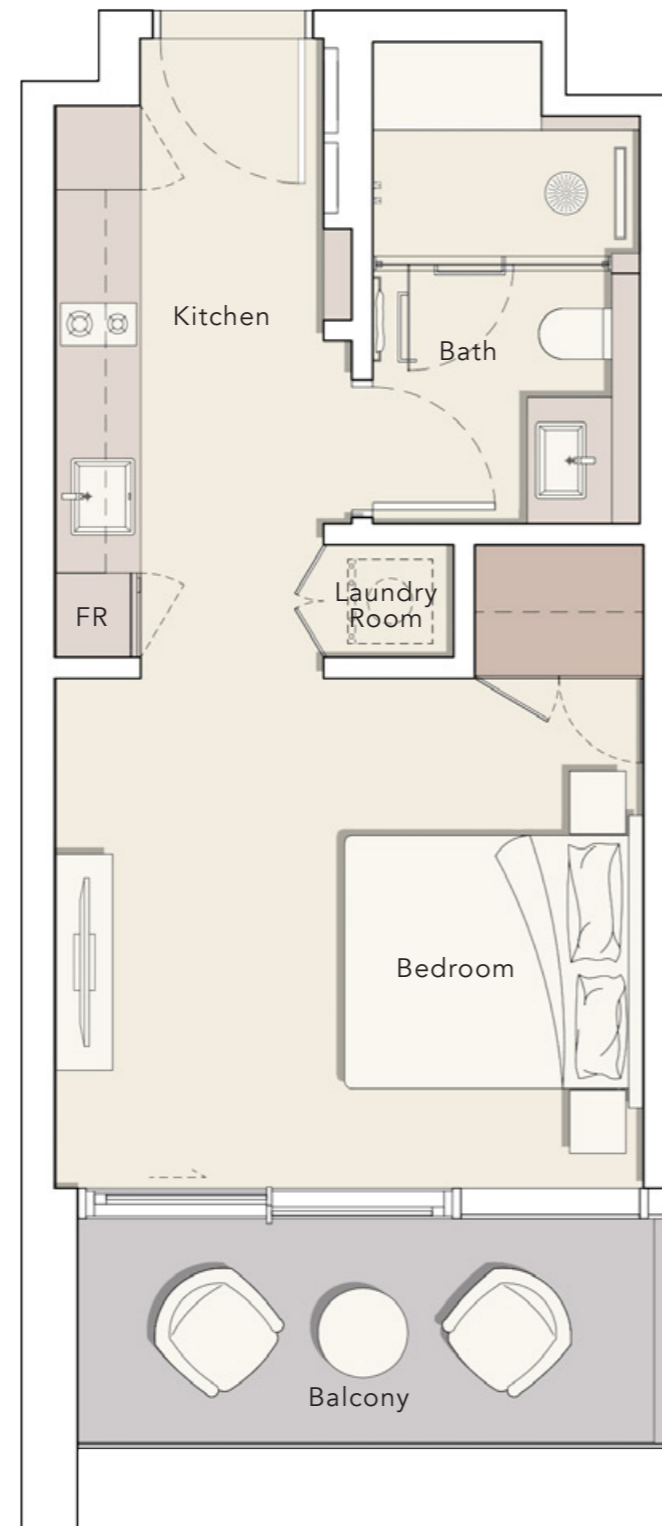

18th - 36th FLOOR

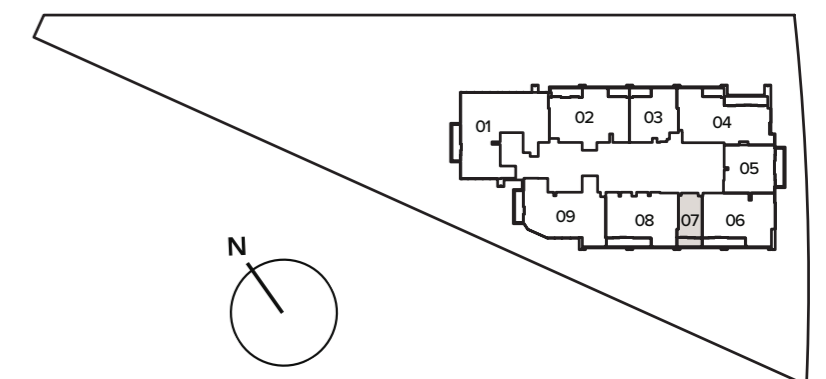

1 BEDROOM

TYPE A

Internal Living Area : 886.41 Sq. Ft

Outdoor Living Area : 71.69 Sq. Ft

Total Living Area : 958.10 Sq. Ft



3rd FLOOR

301

7th FLOOR

701

4th FLOOR

401

8th - 16th FLOOR

803

5th FLOOR

501

18th - 36th FLOOR

1803

6th FLOOR

601

8th - 16th FLOOR

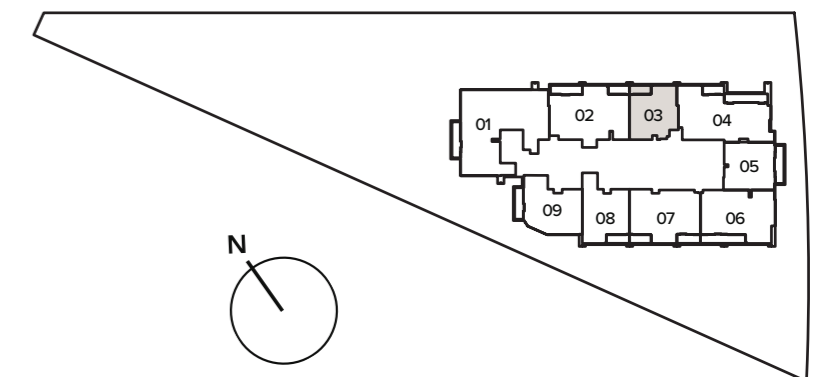

1 BEDROOM

TYPE B

Internal Living Area : 930.43 Sq. Ft
Outdoor Living Area : 129.81 Sq. Ft
Total Living Area : 1060.25 Sq. Ft

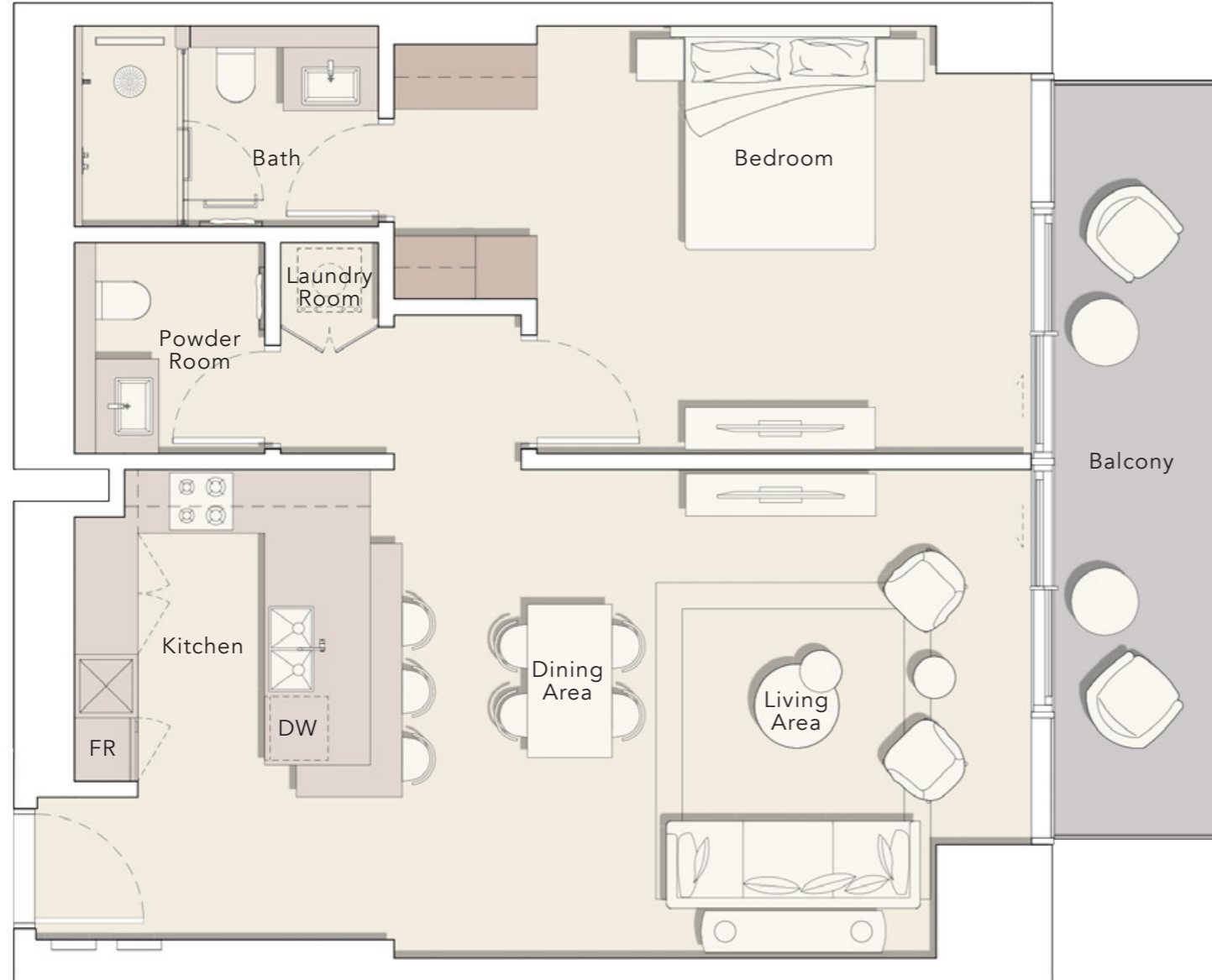

3rd FLOOR
303

7th FLOOR
703

4th FLOOR
403

8th - 16th FLOOR
805

5th FLOOR
503

18th - 36th FLOOR
1805

6th FLOOR
603

8th - 16th FLOOR

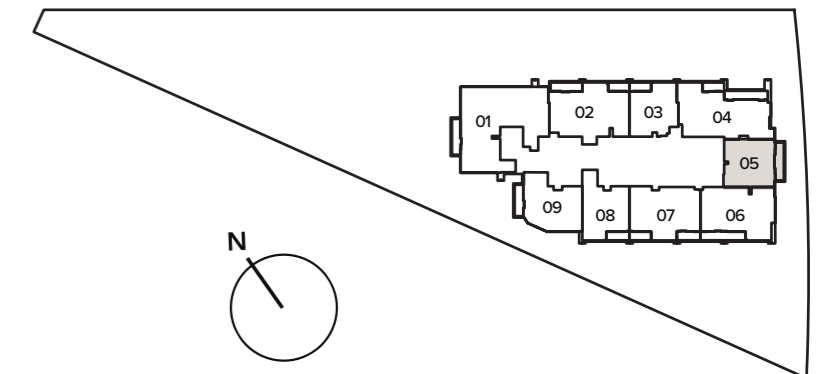

1 BEDROOM

TYPE C

Internal Living Area : 1090.49 Sq. Ft

Outdoor Living Area : 107.10 Sq. Ft

Total Living Area : 1197.59 Sq. Ft



3rd FLOOR

307

7th FLOOR

707

4th FLOOR

407

8th - 16th FLOOR

809

5th FLOOR

507

6th FLOOR

607

8th - 16th FLOOR

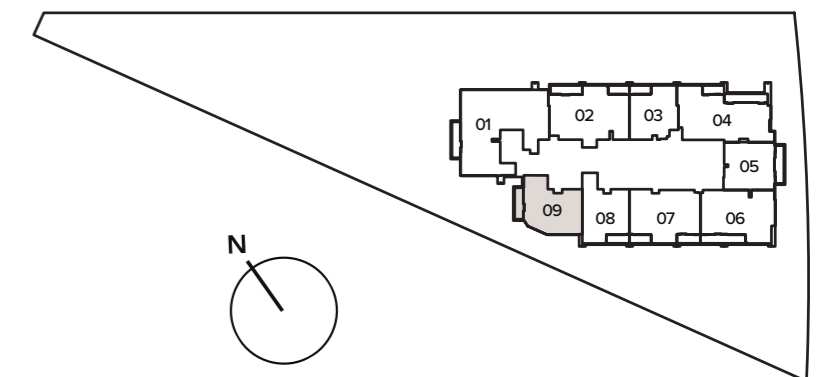

1 BEDROOM

TYPE D

Internal Living Area : 991.03 Sq. Ft

Outdoor Living Area : 77.82 Sq. Ft

Total Living Area : 1068.86 Sq. Ft

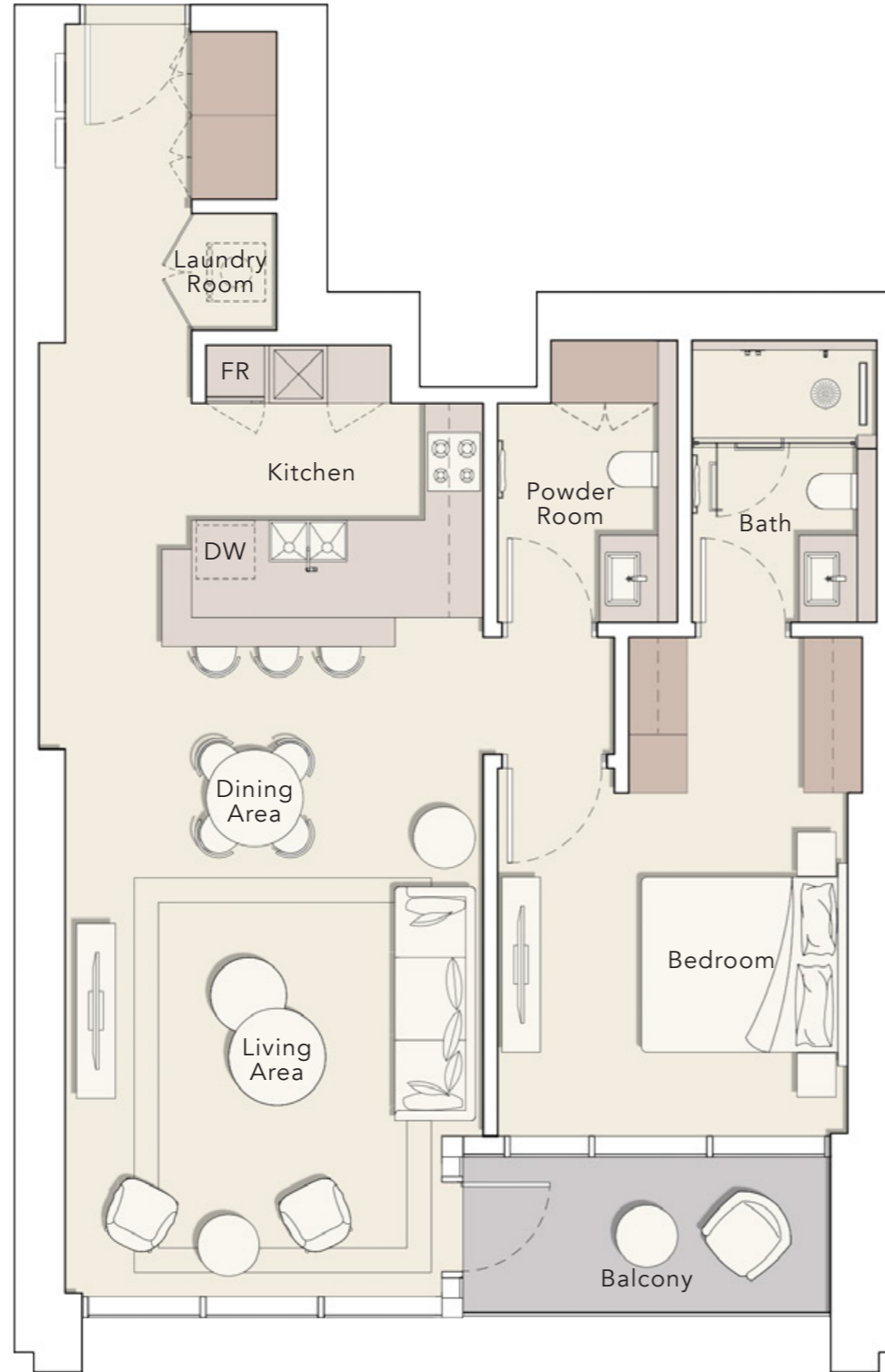

3rd FLOOR

306

7th FLOOR

706

4th FLOOR

406

8th - 16th FLOOR

808

5th FLOOR

506

6th FLOOR

606

8th - 16th FLOOR

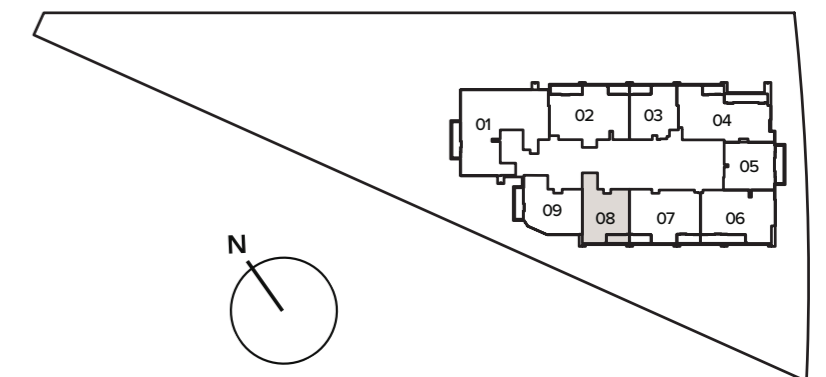

2 BEDROOM

TYPE A

Internal Living Area : 1337.31 Sq. Ft

Outdoor Living Area : 152.63 Sq. Ft

Total Living Area : 1489.94 Sq. Ft

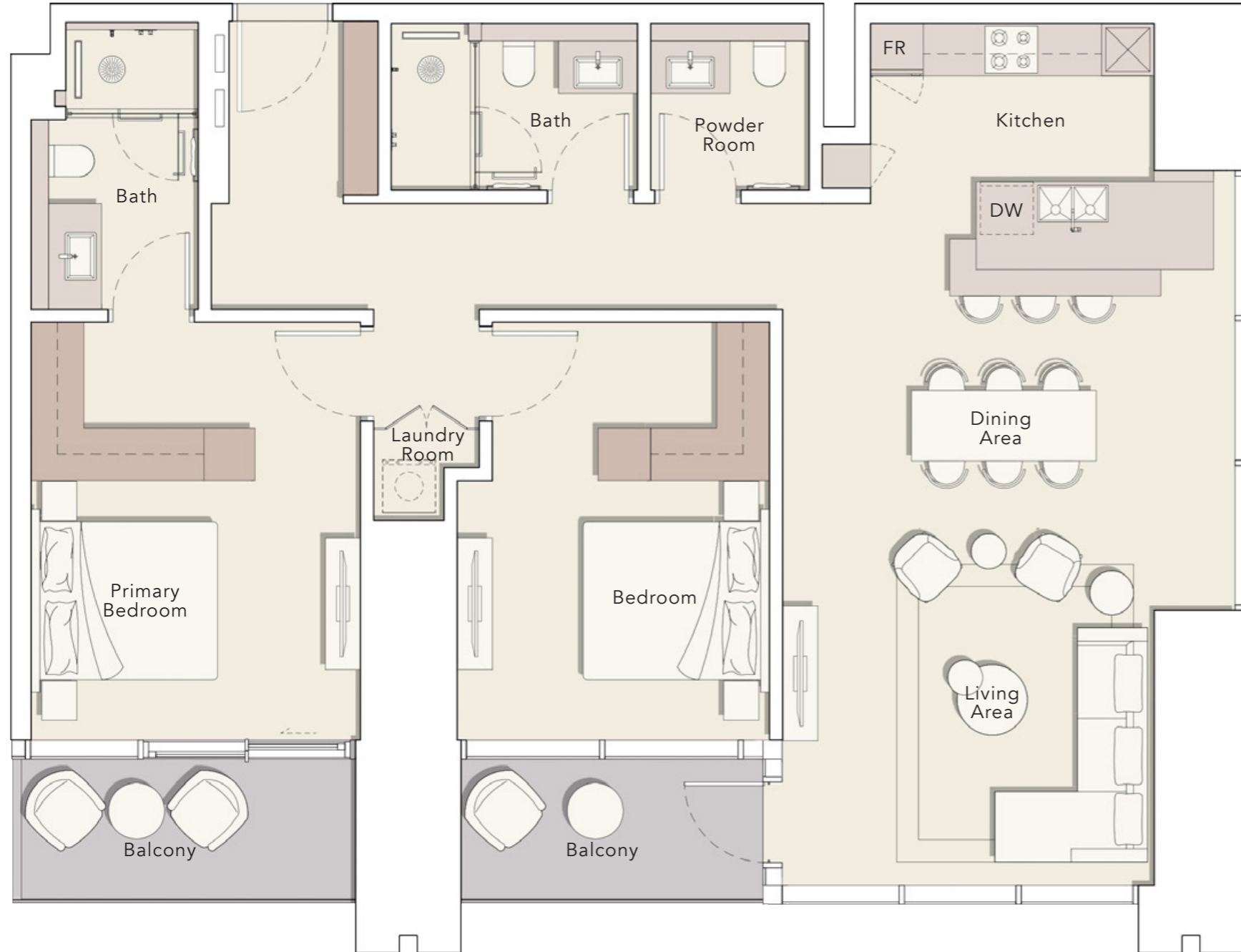

3rd FLOOR

304

7th FLOOR

704

4th FLOOR

404

8th - 16th FLOOR

806

5th FLOOR

504

18th - 36th FLOOR

1806

6th FLOOR

604

8th - 16th FLOOR

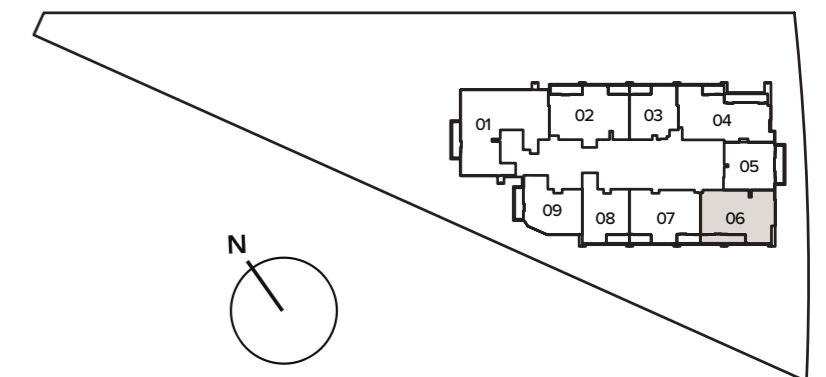

2 BEDROOM

TYPE B

Internal Living Area : 1295.22 Sq. Ft

Outdoor Living Area : 152.63 Sq. Ft

Total Living Area : 1447.85 Sq. Ft



3rd FLOOR

305

7th FLOOR

705

4th FLOOR

405

8th - 16th FLOOR

807

5th FLOOR

505

6th FLOOR

605

8th - 16th FLOOR

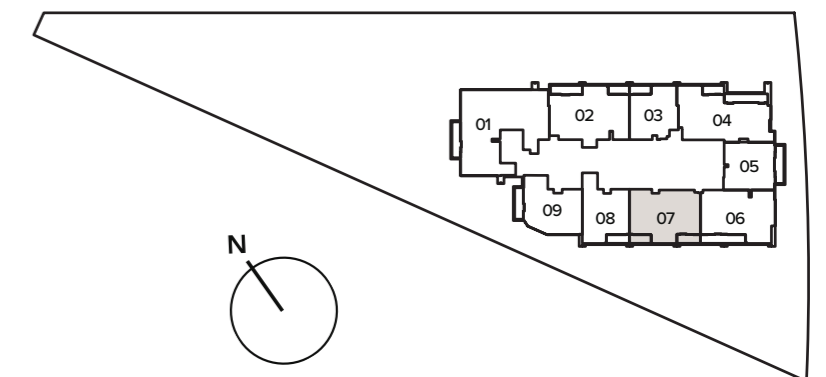

2 BEDROOM

TYPE C

Internal Living Area : 1328.48 Sq. Ft

Outdoor Living Area : 151.77 Sq. Ft

Total Living Area : 1480.25 Sq. Ft



18th - 36th FLOOR

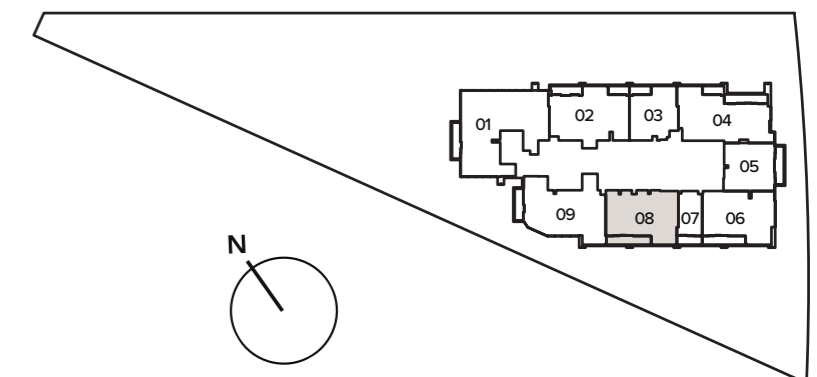

2 BEDROOM + S

TYPE A

Internal Living Area : 1573.04 Sq. Ft

Outdoor Living Area : 222.92 Sq. Ft

Total Living Area : 1795.96 Sq. Ft

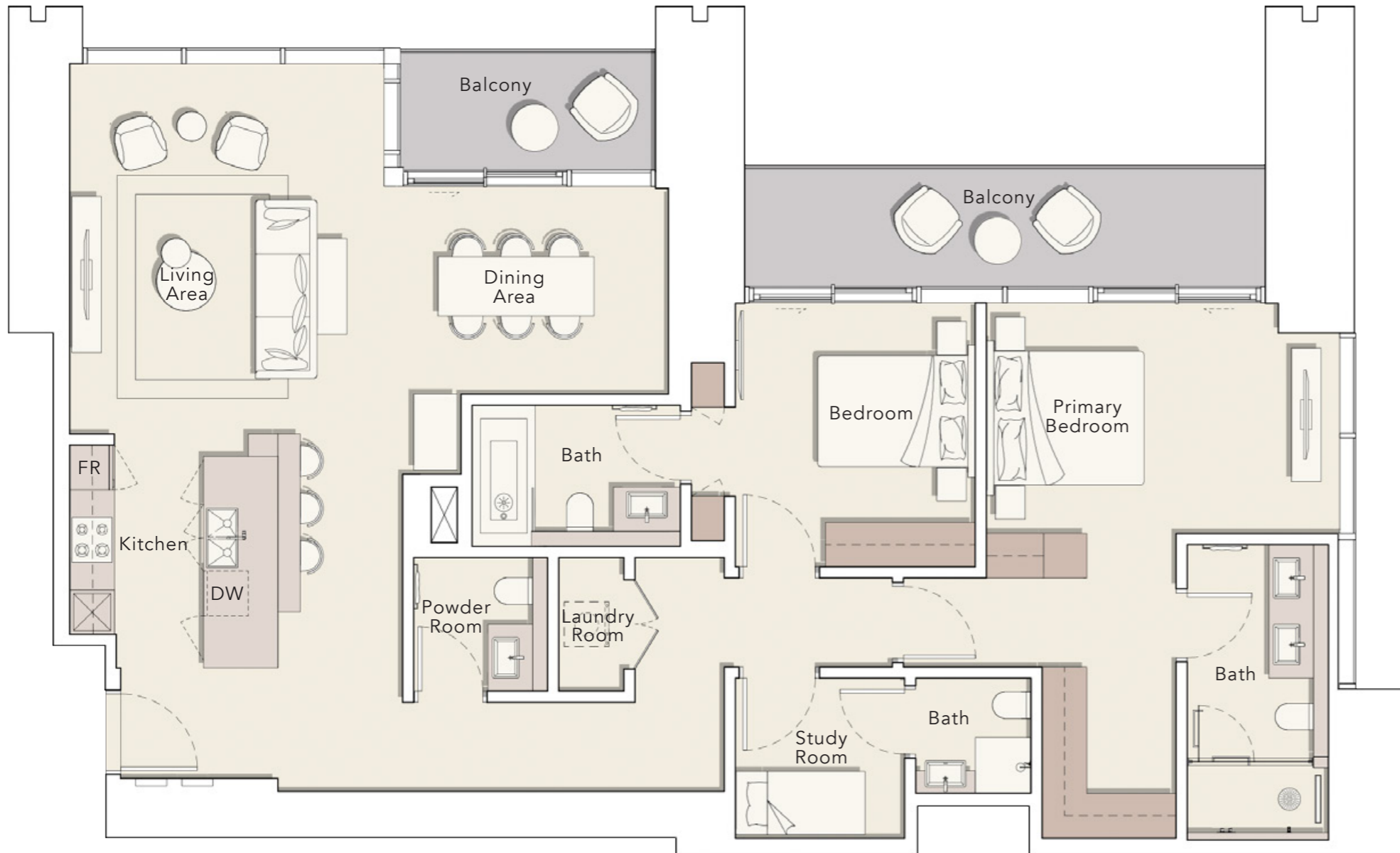

3rd FLOOR

302

4th FLOOR

402

5th FLOOR

502

6th FLOOR

602

7th FLOOR

702

8th - 16th FLOOR

804

18th - 36th FLOOR

1804

8th - 16th FLOOR

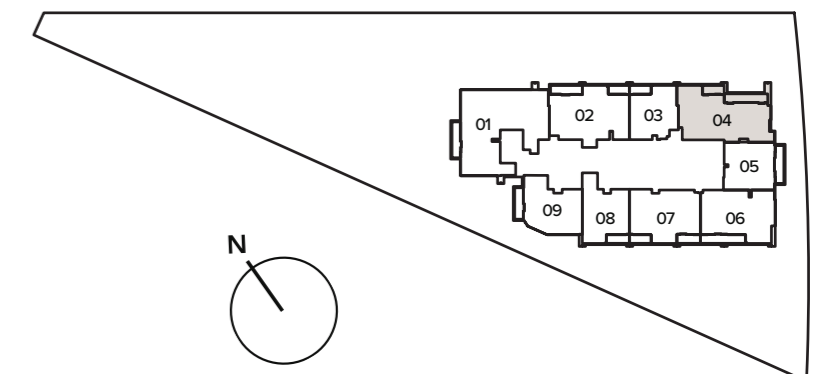

2 BEDROOM + S

TYPE B

Internal Living Area : 1509.53 Sq. Ft

Outdoor Living Area : 178.79 Sq. Ft

Total Living Area : 1688.32 Sq. Ft



8th - 16th FLOOR

802

18th - 36th FLOOR

1802

8th - 16th FLOOR

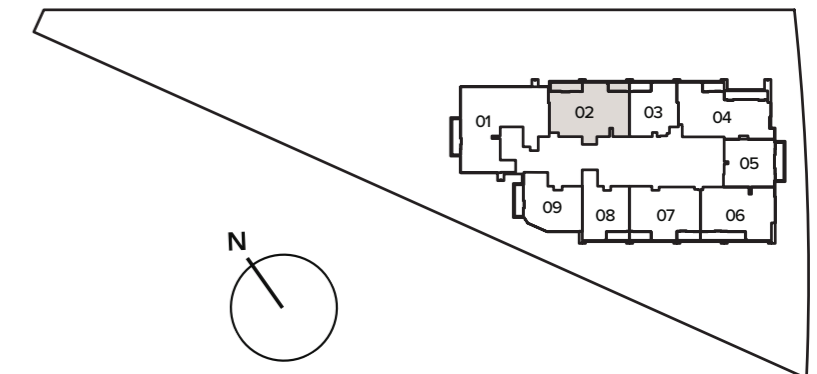

2 BEDROOM + S

TYPE C

Internal Living Area : 1678.20 Sq. Ft

Outdoor Living Area : 107.10 Sq. Ft

Total Living Area : 1785.30 Sq. Ft



18th - 36th FLOOR

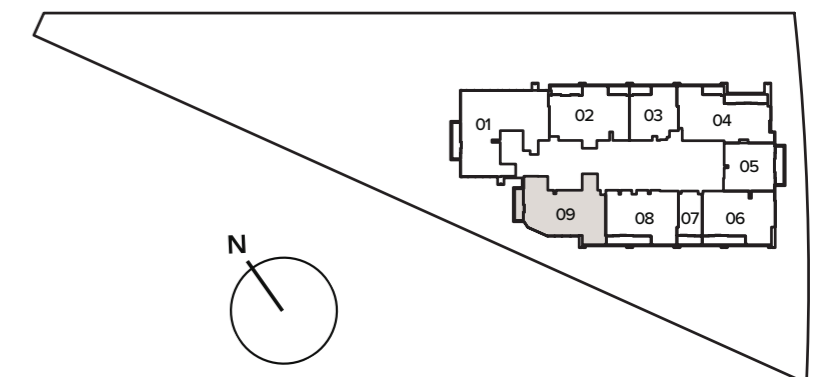

3 BEDROOM

TYPE A

Internal Living Area : 2276.24 Sq. Ft

Outdoor Living Area : 121.09 Sq. Ft

Total Living Area : 2397.34 Sq. Ft



8th - 16th FLOOR

801

18th - 36th FLOOR

1801

8th - 16th FLOOR

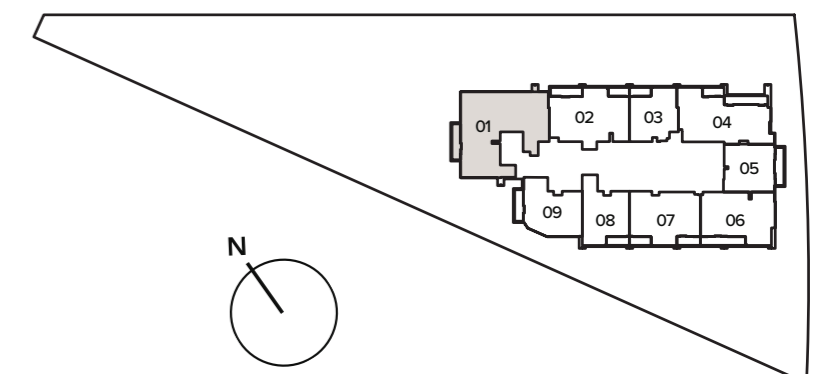

P R E M I U M
A P A R T M E N T S

3 BEDROOM DUPLEX

TYPE A

Internal Living Area : 3007.22 Sq. Ft

Outdoor Living Area : 707.30 Sq. Ft

Total Living Area : 3714.52 Sq. Ft

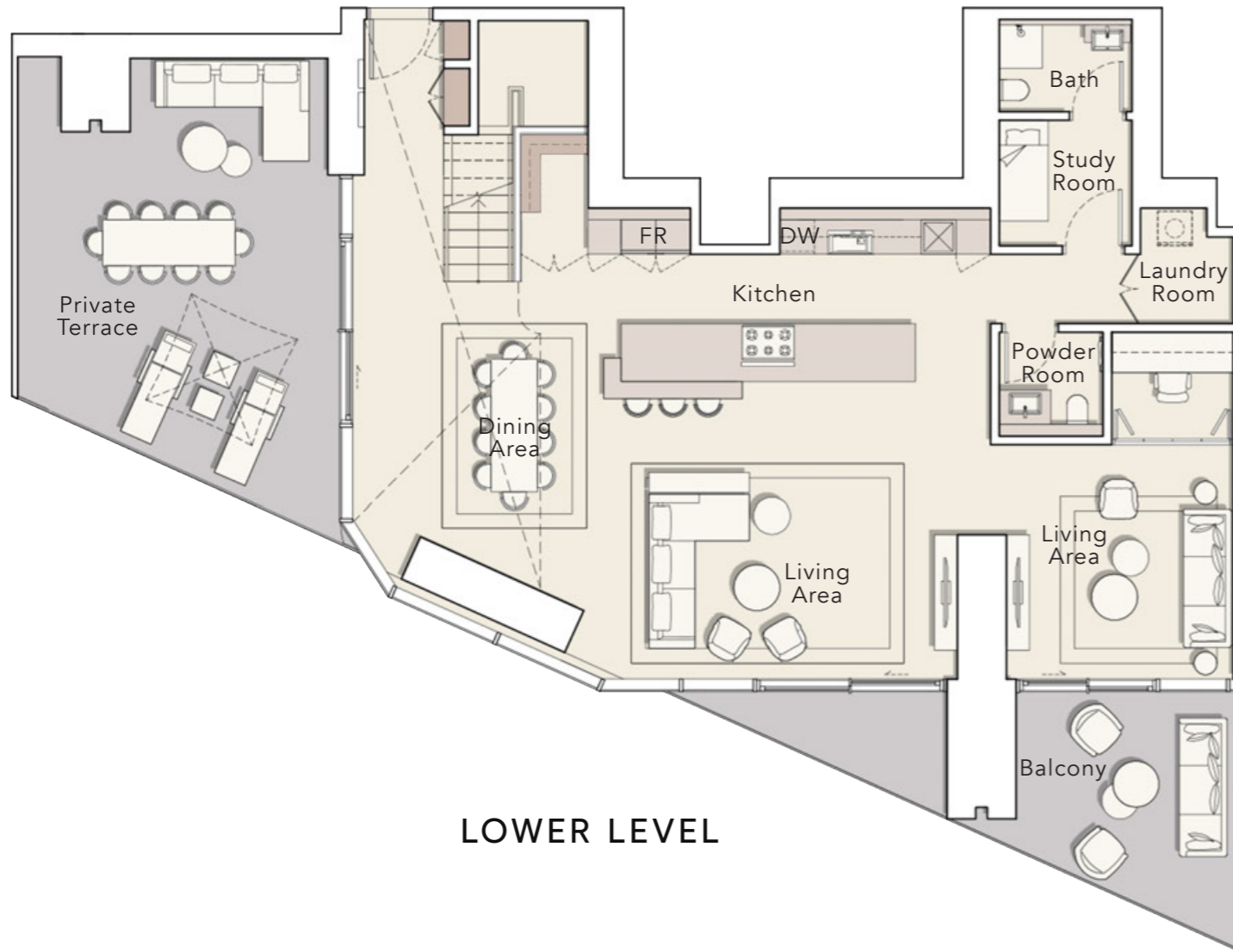

LOWER LEVEL

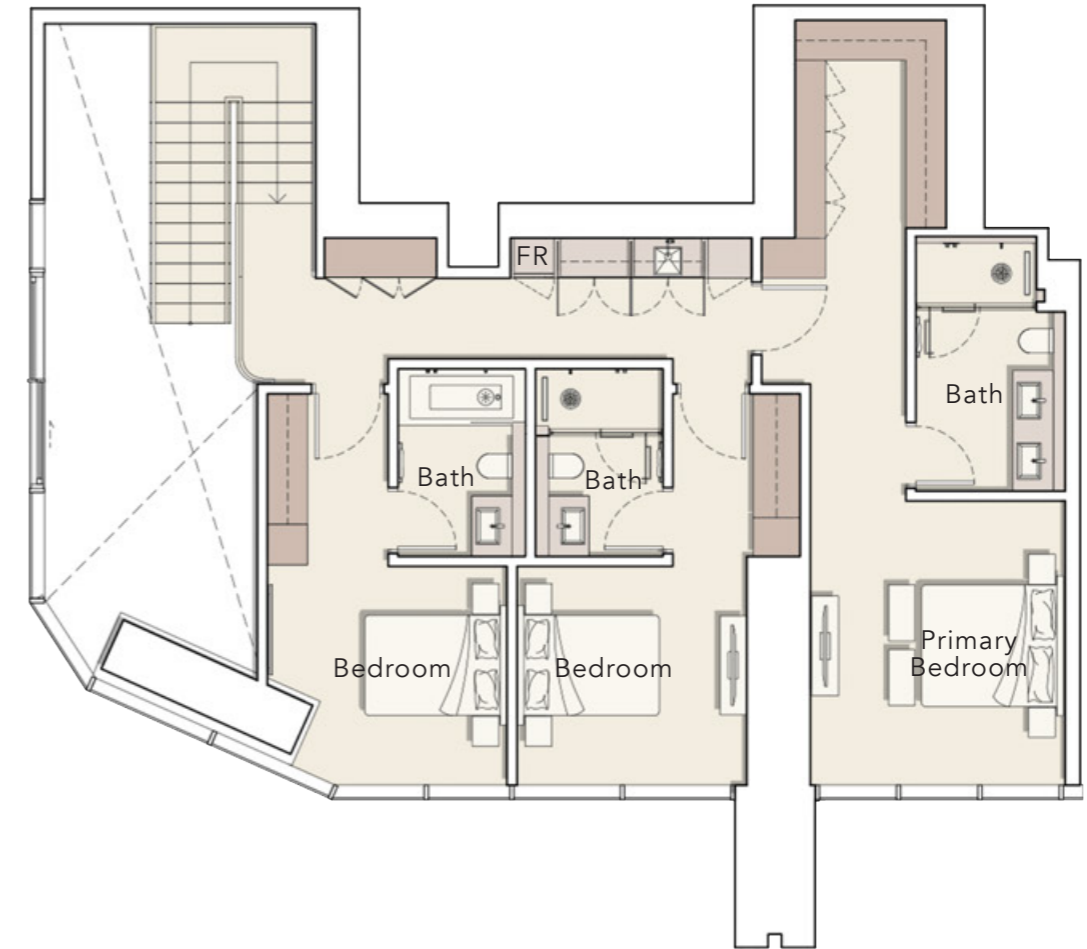

UPPER LEVEL

1st FLOOR

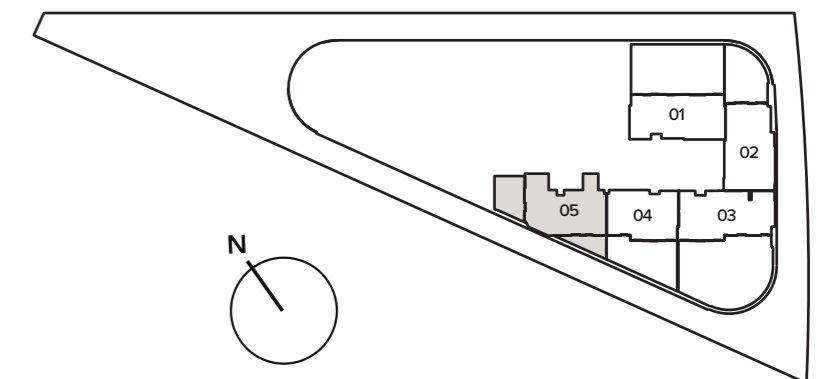

3 BEDROOM DUPLEX

TYPE B

Internal Living Area : 2468.49 Sq. Ft

Outdoor Living Area : 993.62 Sq. Ft

Total Living Area : 3462.10 Sq. Ft

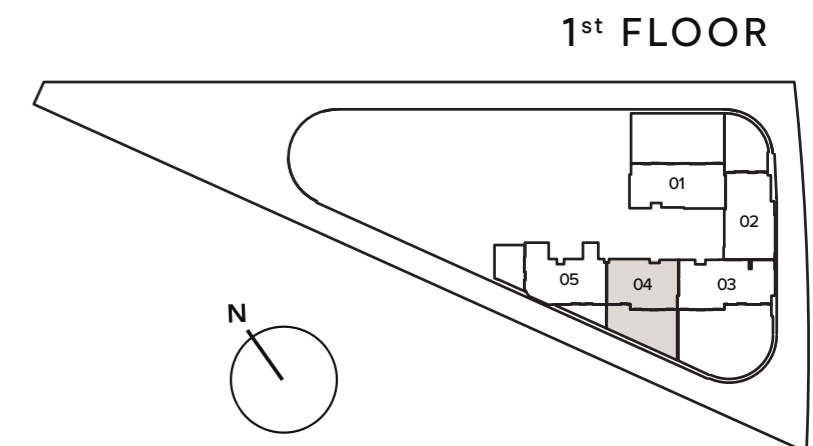
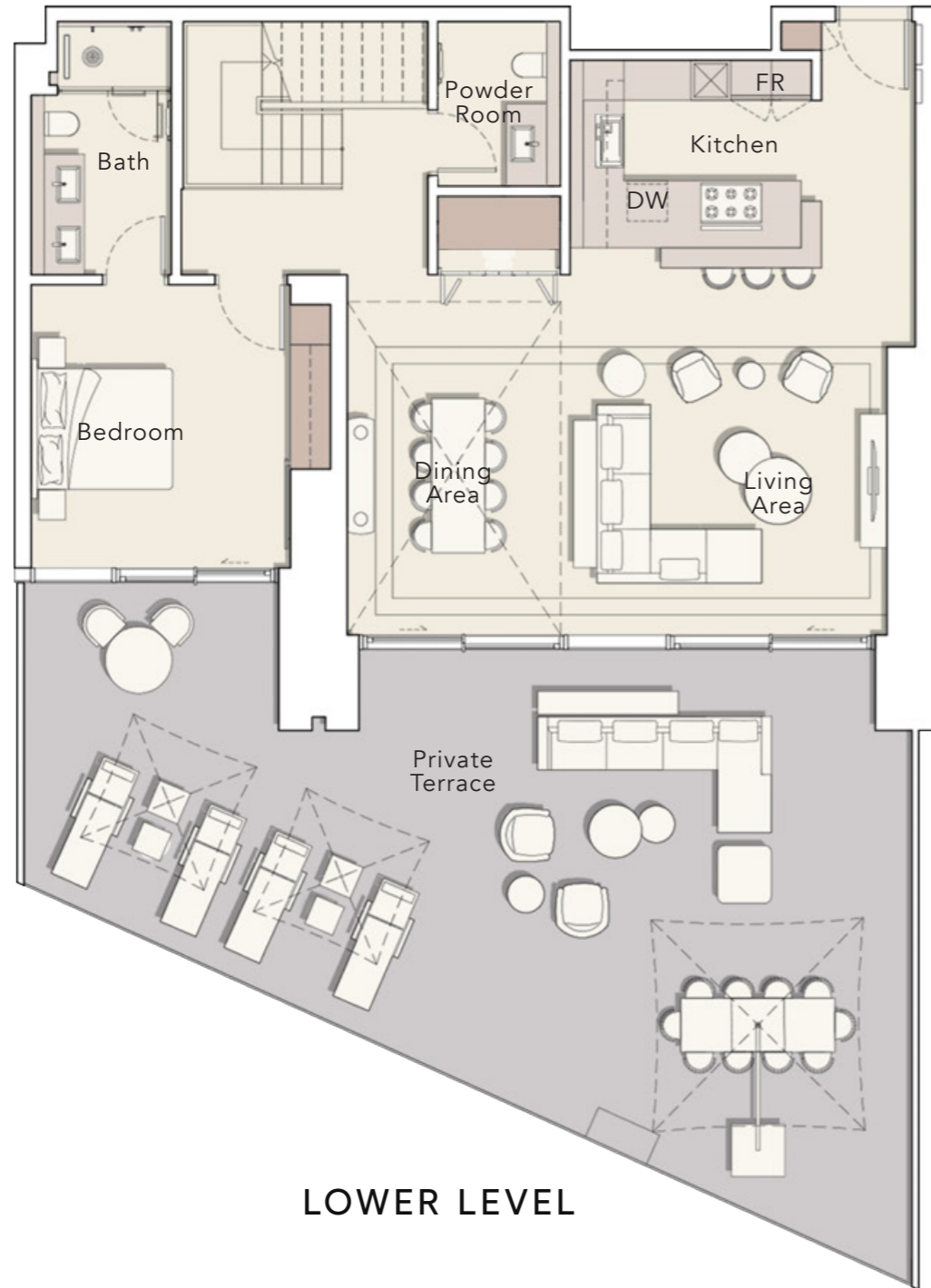

3 BEDROOM DUPLEX

TYPE C

Internal Living Area : 3125.73 Sq. Ft

Outdoor Living Area : 842.92 Sq. Ft

Total Living Area : 3968.65 Sq. Ft

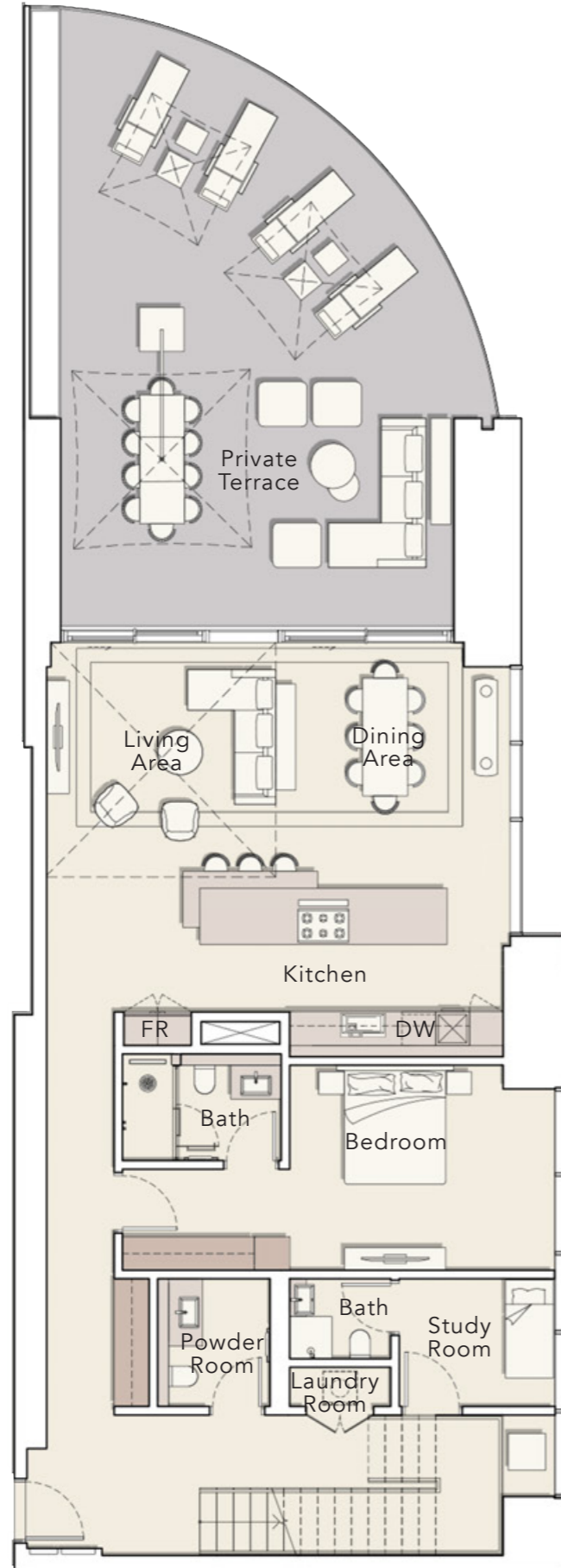

LOWER LEVEL

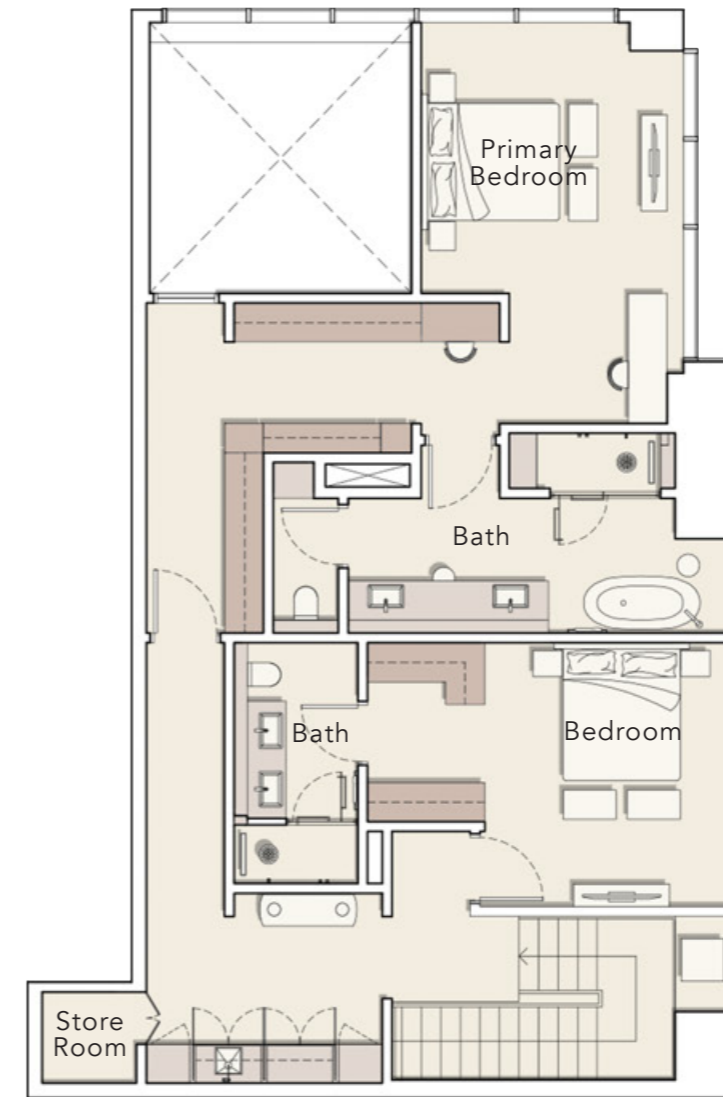

UPPER LEVEL

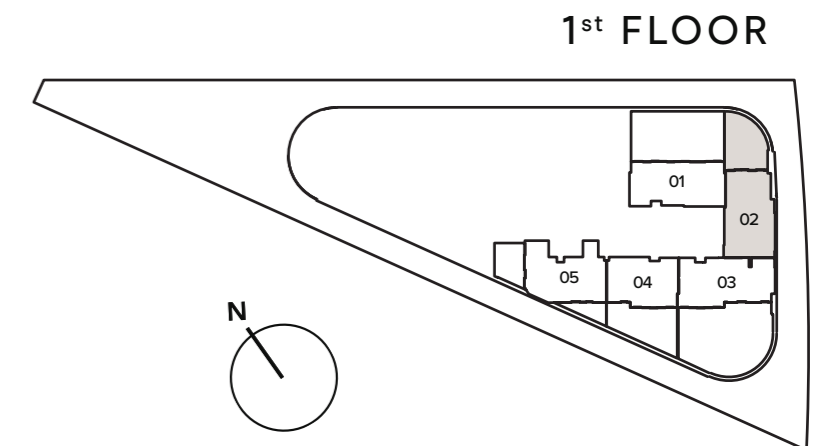

1st FLOOR

4 BEDROOM DUPLEX

TYPE A

Internal Living Area : 3128.96 Sq. Ft

Outdoor Living Area : 1842.89 Sq. Ft

Total Living Area : 4971.85 Sq. Ft

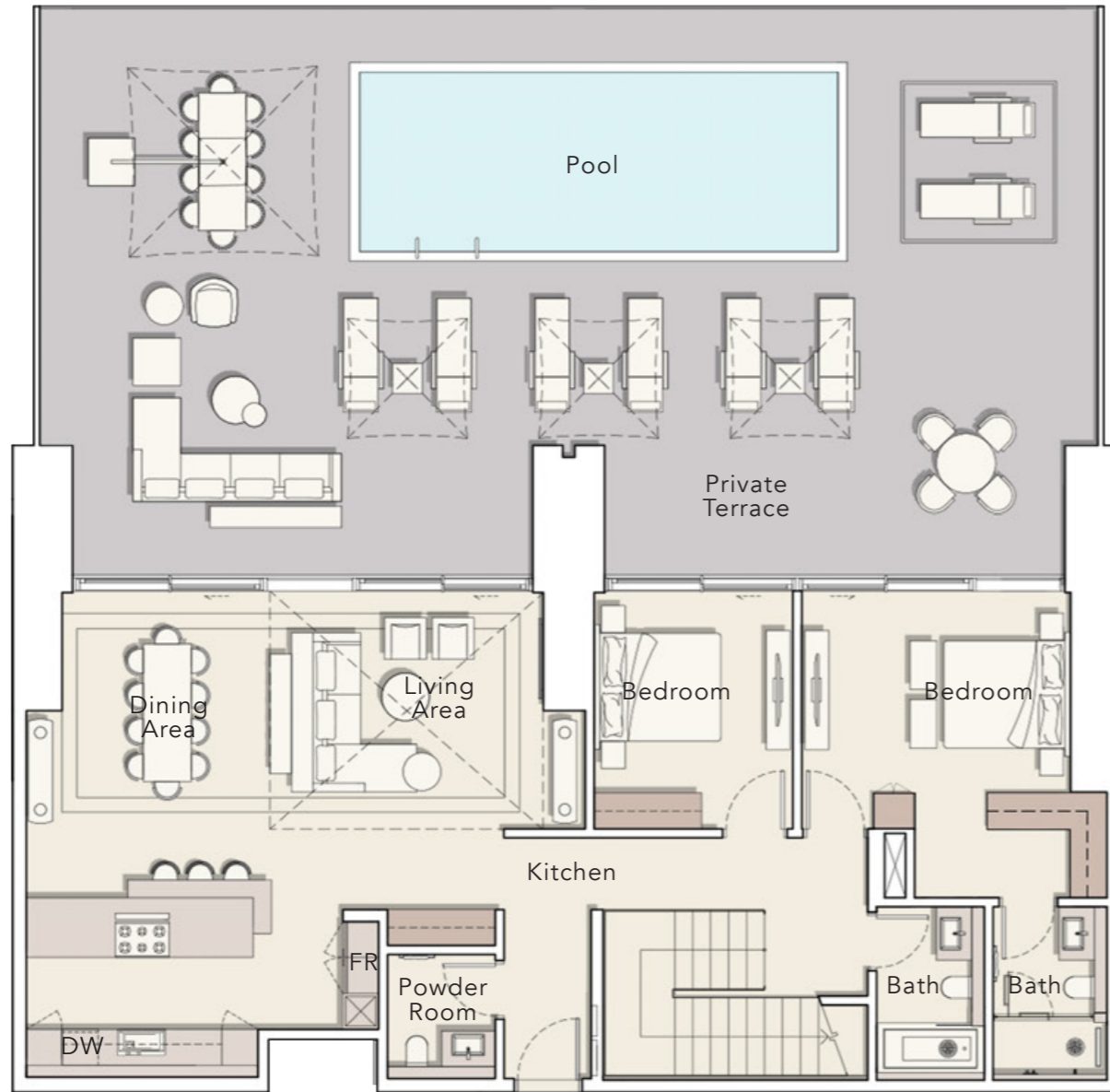

LOWER LEVEL

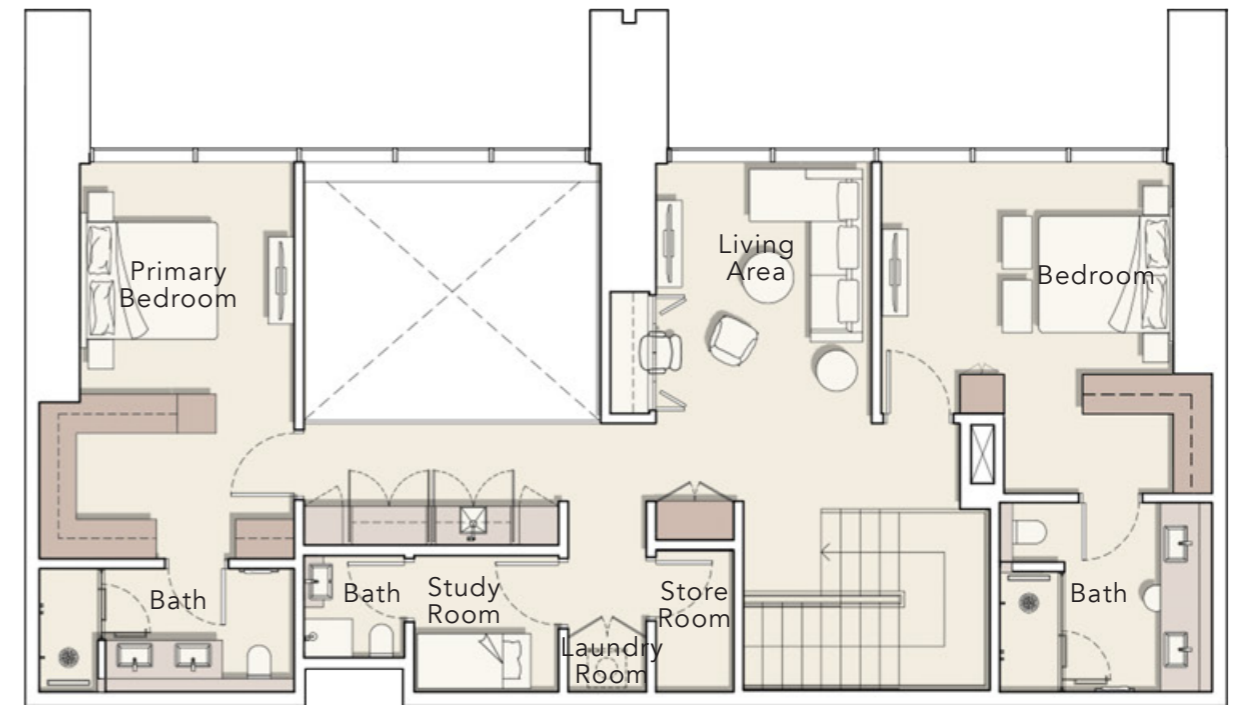

UPPER LEVEL

1st FLOOR

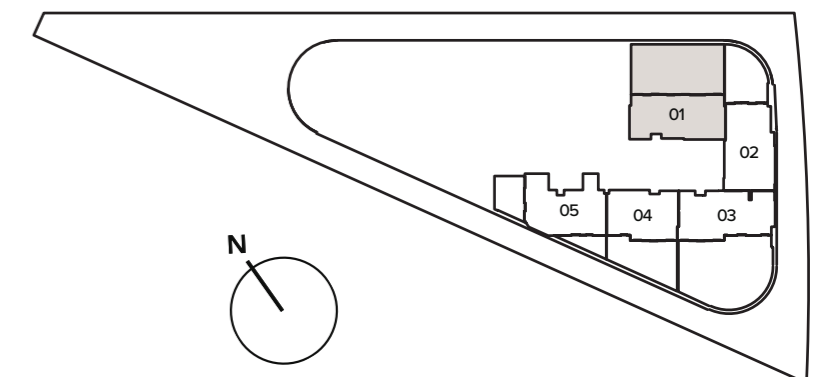

4 BEDROOM DUPLEX

TYPE B

Internal Living Area : 3246.50 Sq. Ft

Outdoor Living Area : 2329.74 Sq. Ft

Total Living Area : 5576.24 Sq. Ft

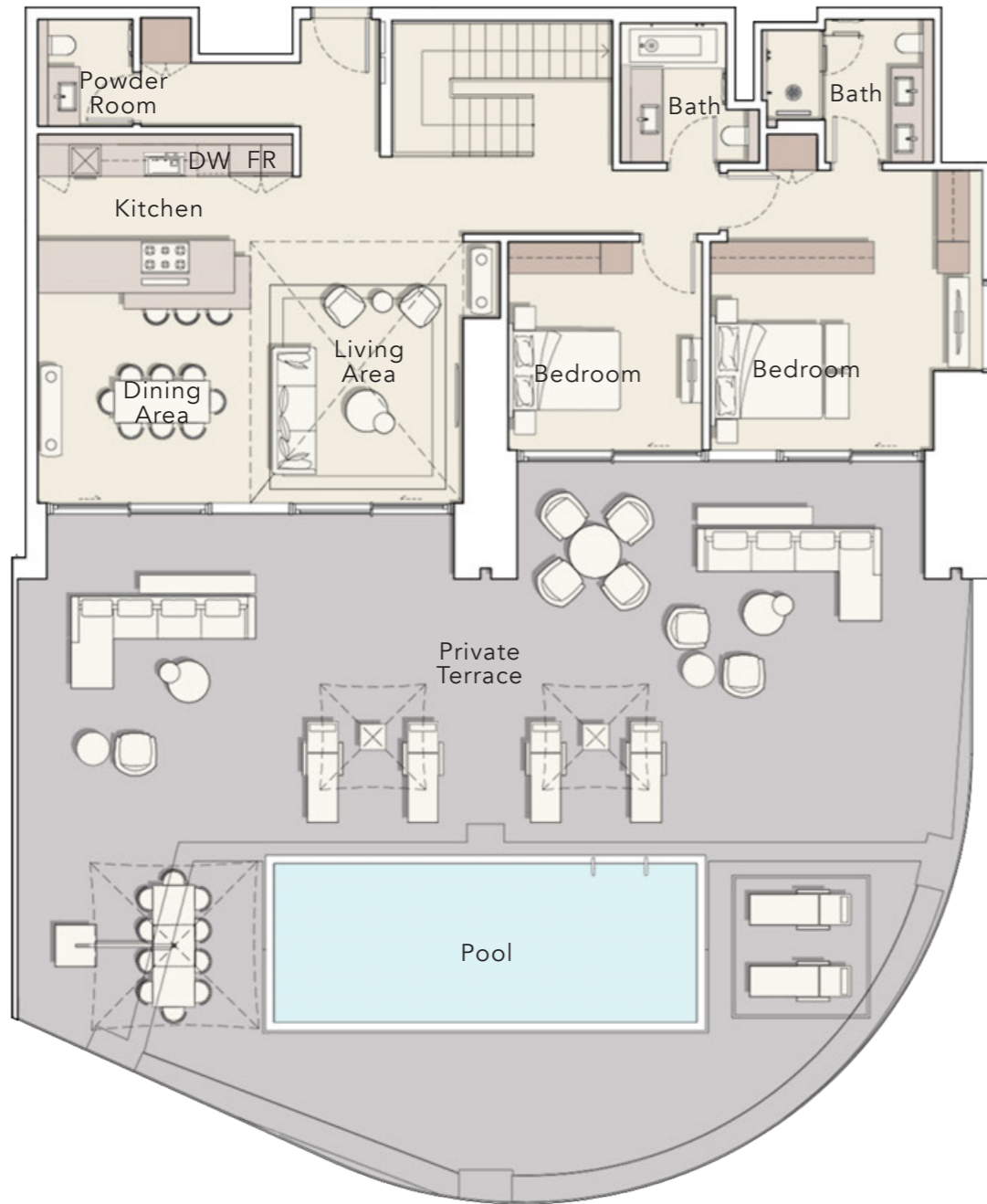

LOWER LEVEL

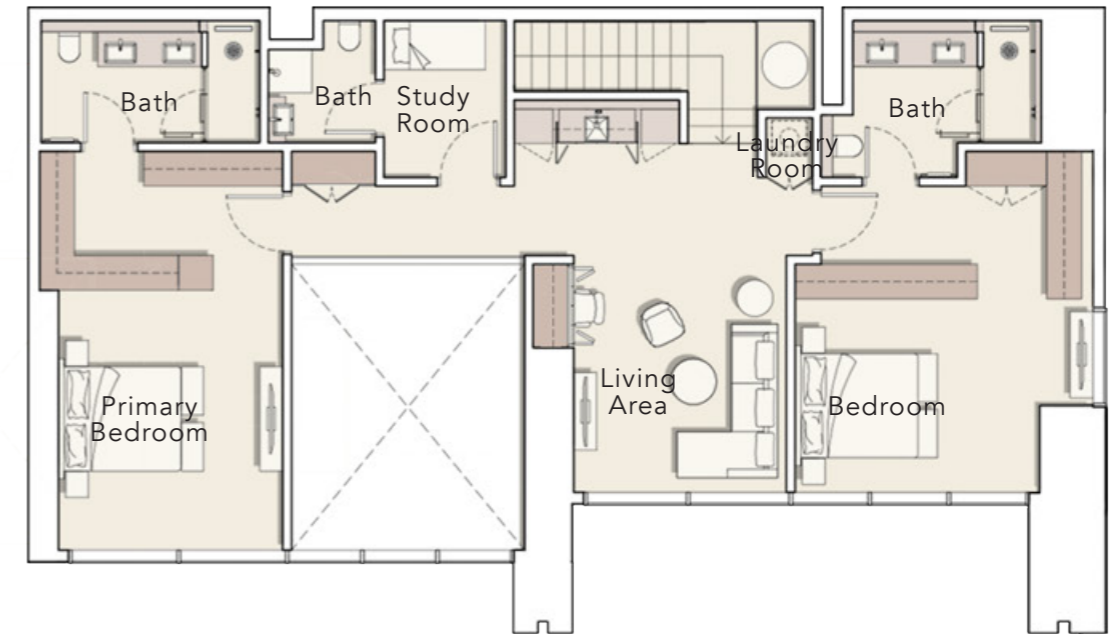

UPPER LEVEL

1st FLOOR

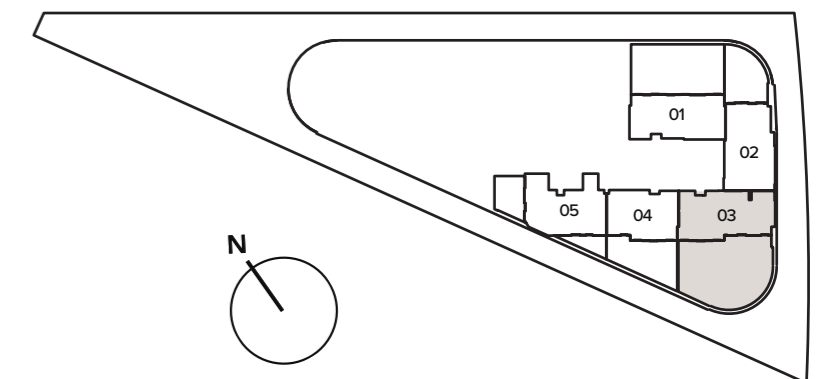

PENTHOUSE

TYPE A

Internal Living Area : 3398.92 Sq. Ft

Outdoor Living Area : 2448.57 Sq. Ft

Total Living Area : 5847.49 Sq. Ft

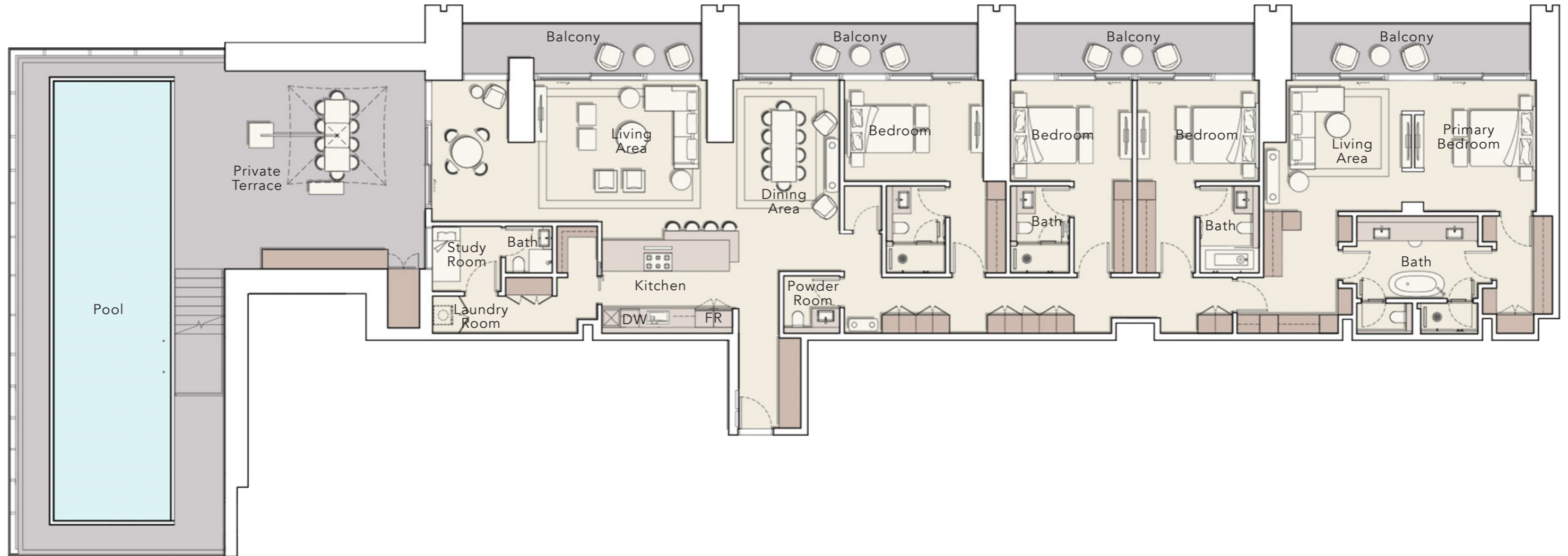

37th FLOOR

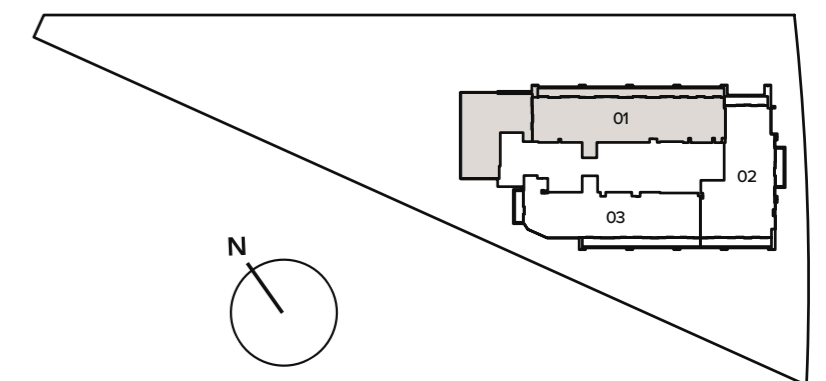

PENTHOUSE

TYPE B

Internal Living Area : 3221.42 Sq. Ft

Outdoor Living Area : 513.22 Sq. Ft

Total Living Area : 3734.65 Sq. Ft

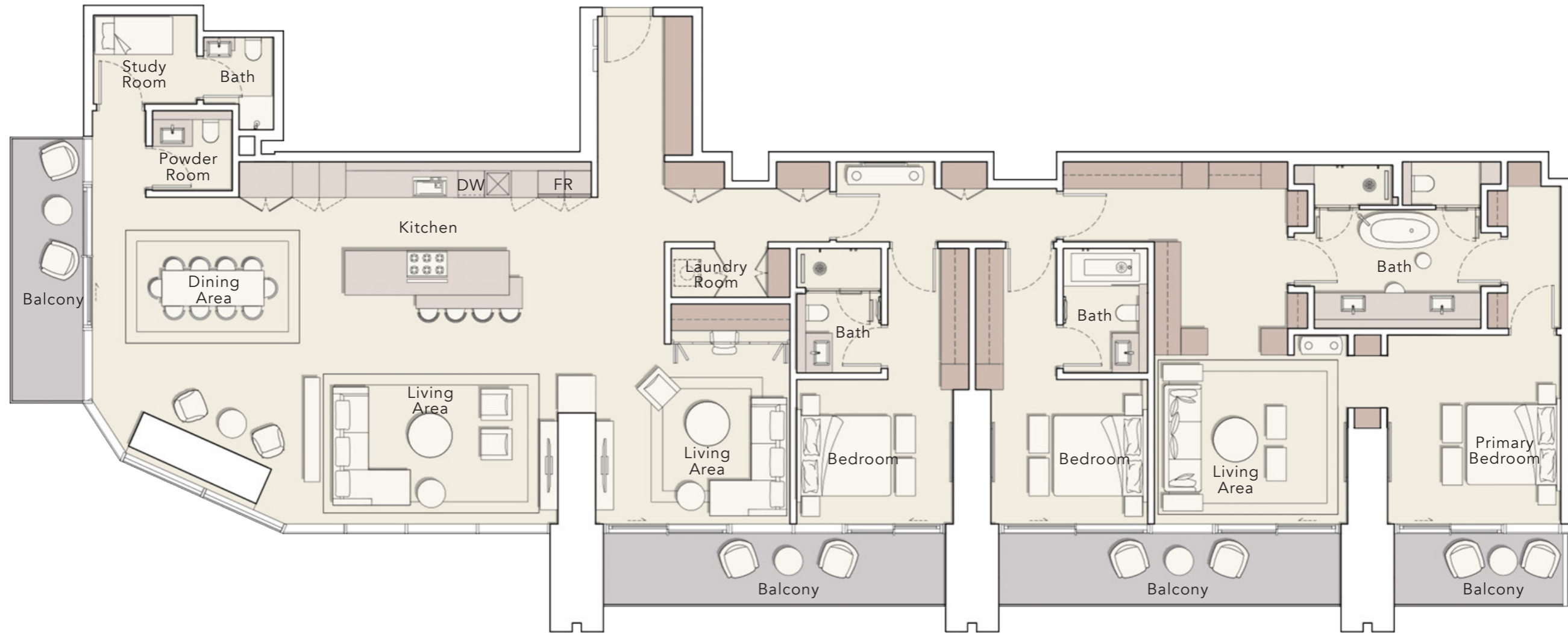

37th FLOOR

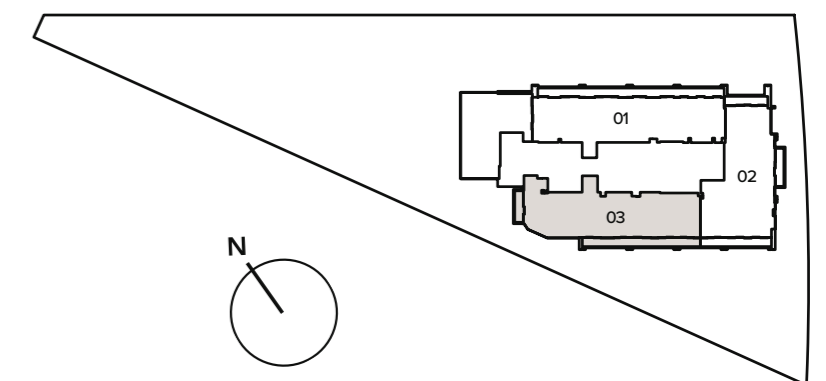

PENTHOUSE

TYPE C

Internal Living Area : 2980.96 Sq. Ft

Outdoor Living Area : 521.83 Sq. Ft

Total Living Area : 3502.79 Sq. Ft

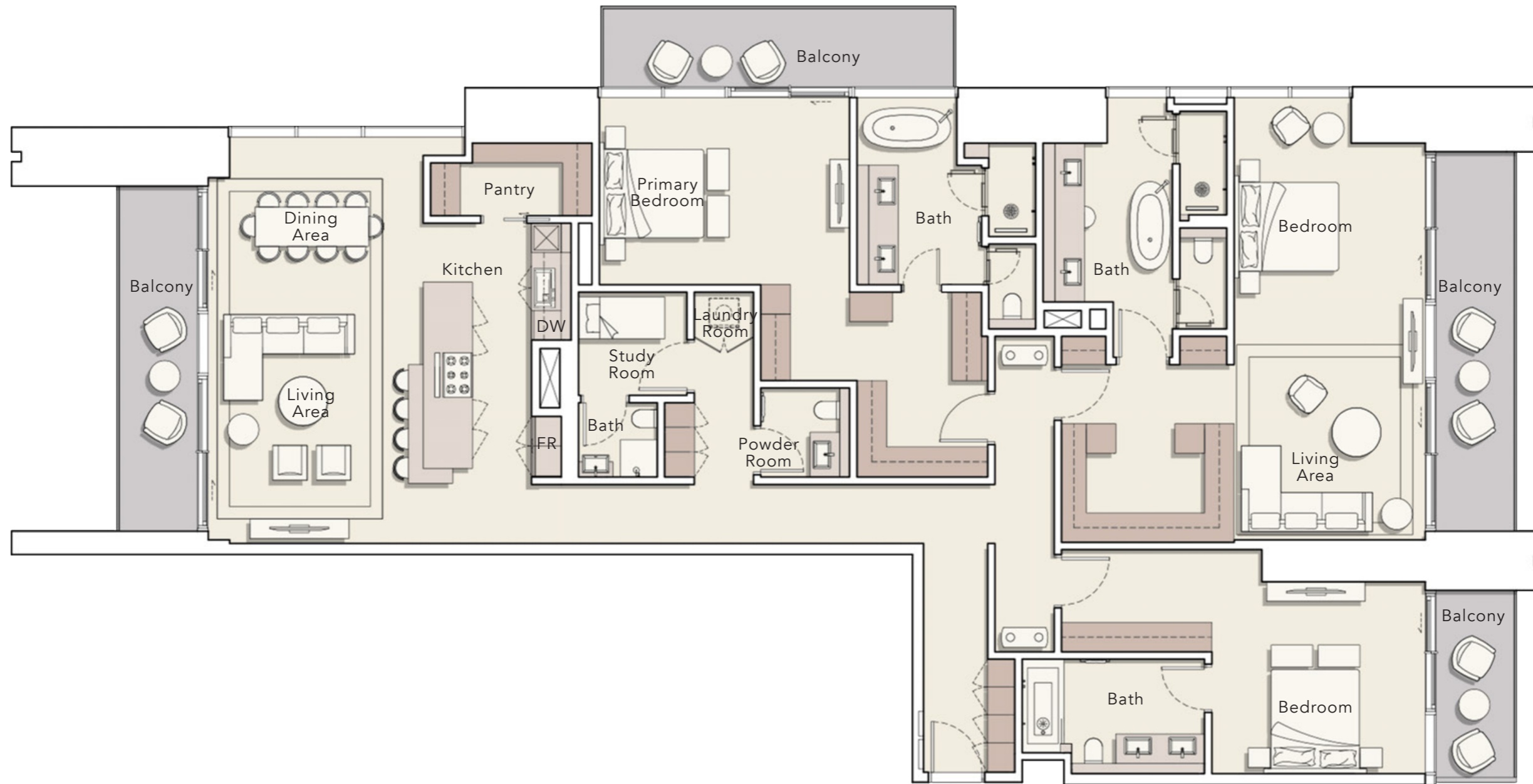

37th FLOOR

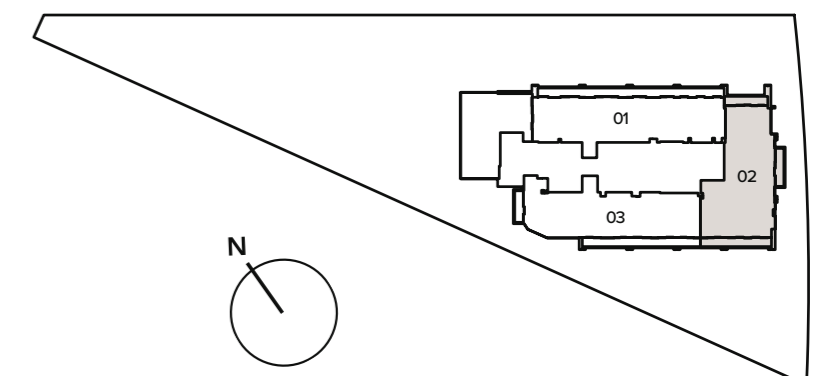

 ELLINGTON | **DUTCO**